

# Potain Igo MA 21

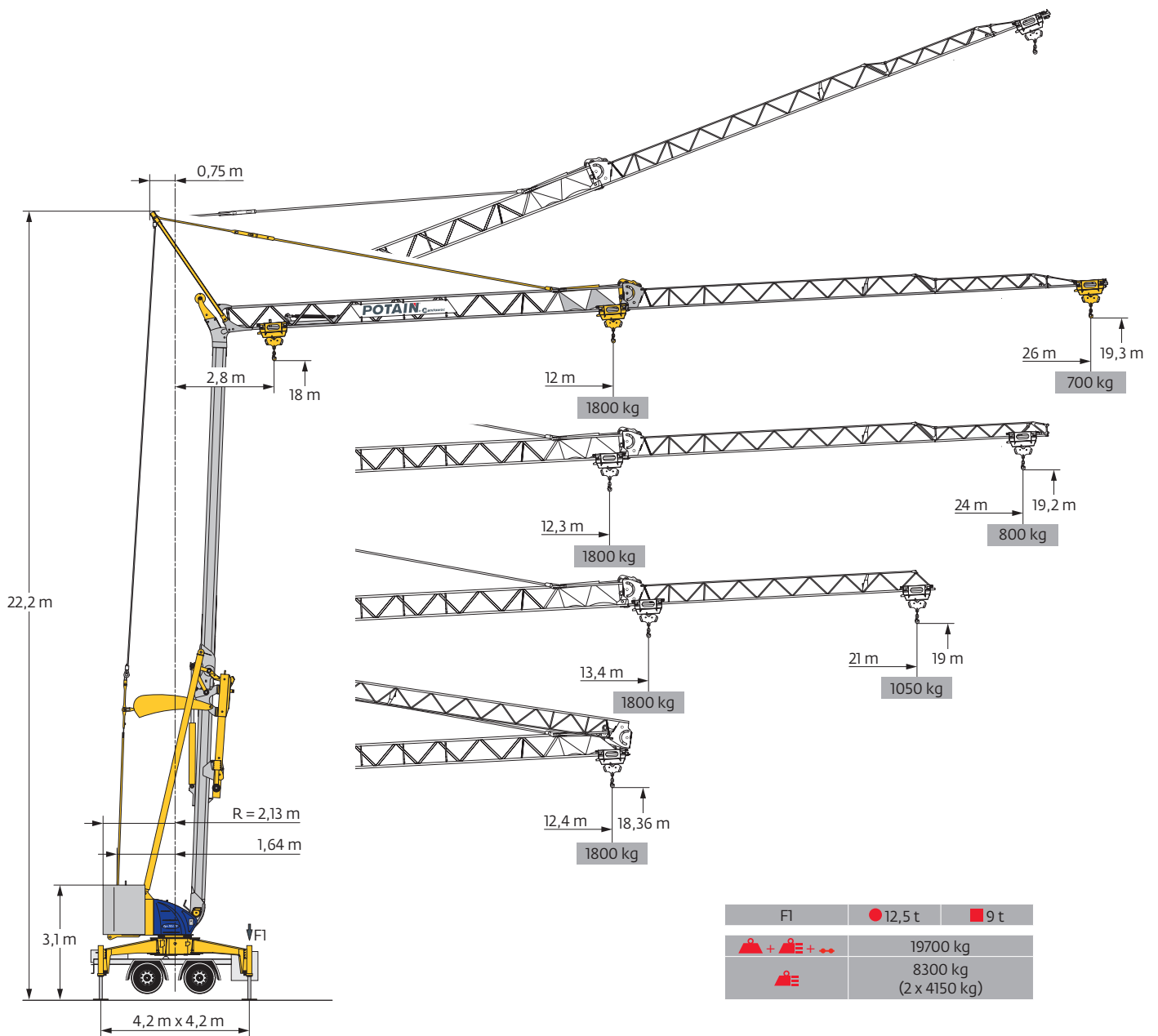

Courbes de charges / Lastkurven / Load curves / Curvas de cargas / Curve di carico  
 Curvas de carga / Кривые нагрузок

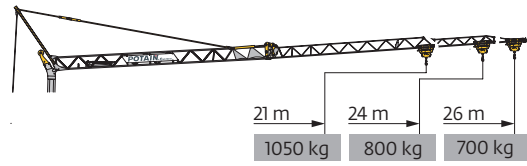
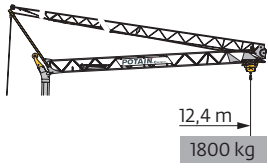

26 m	2,8	▶	12,4	m
			1800	kg
24 m	2,8	▶	12,4	m
			1800	kg
21 m	2,8	▶	12,4	m
			1800	kg

2,8	▶	12	13	14	15	16	17	18	19	20	21	22	23	24	25	26	m
		1800	1630	1490	1370	1265	1175	1095	1025	965	910	860	815	775	735	700	kg
2,8	▶	12,3	13	14	15	16	17	18	19	20	21	22	23	24			m
		1800	1685	1535	1415	1310	1215	1135	1060	1000	940	890	845	800			kg
2,8	▶		13,4	14	15	16	17	18	19	20	21						m
			1800	1710	1570	1455	1350	1265	1185	1115	1050						kg

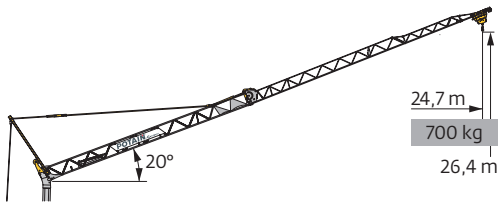

26 m	2,8	▶															24,7	m
																	700	kg





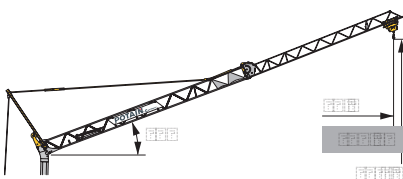

24 m	2,8	▶															22,8	m
																	700	kg



21 m	2,8	▶								20	m							
										700	kg							

Mécanismes / Triebwerke / Mechanisms / Mecanismos / Meccanismi  
 Mecanismos / Механизмы

230 V - 50 Hz 400 V - 50 Hz 480 V - 60 Hz							ch - PS hp	kW
	<b>8 LVF 9 Optima</b>	230 V $\overline{--}$	m/min	$\updownarrow$ 3,5	$\uparrow$ 7 $\downarrow$ 16	$\uparrow$ 18 $\downarrow$ 36	3,3	2,4
		20 A <b>1</b>	kg	1800	1800	700		
		230 V $\overline{--}$	m/min	$\updownarrow$ 3,5	$\uparrow$ 11 $\downarrow$ 16	$\uparrow$ 25 $\downarrow$ 36	5,2	3,8
		32 A <b>2</b>	kg	1800	1800	700		
		400 V <b>3</b>	m/min	$\updownarrow$ 3,5	$\updownarrow$ 16	$\updownarrow$ 36	7,5	5,5
			kg	1800	1800	700		
	<b>1 DVF 4</b>		m/min	14 $\rightarrow$ 36 (0 $\rightarrow$ 700 kg) 14 $\rightarrow$ 28 (700 $\rightarrow$ 1800 kg)			1,5	1,1
	<b>RVF 20</b>		tr/min U/min rpm	0 $\rightarrow$ 1			1,5	1,1

 IEC 60204-32	 kVA
230 V (+10% -10%) 50 Hz 400 V (+10% -10%) 50 Hz 480 V (+6% -10%) 60Hz	230 V 20A : 4,6 kVA 230 V 32A : 7,4 kVA 400 V / 480 V : 11 kVA

**8 LVF 9 Optima**

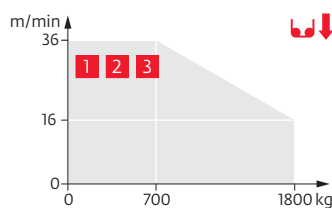
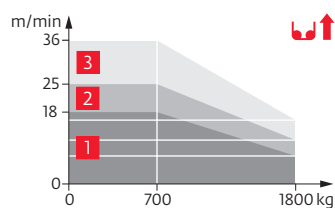

Montage / Montage / Erection / Montaje / Montaggio  
 Montagem / Монтаж

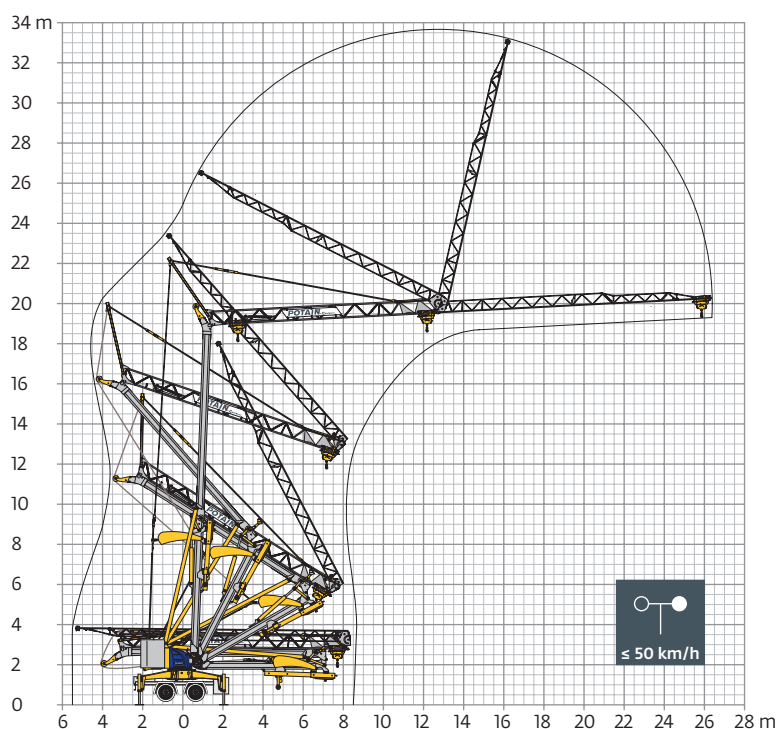

Transport / Transport / Transport / Transporte / Trasporto  
Transporte / Транспортировка

Igo MA 21 | km/h  
80

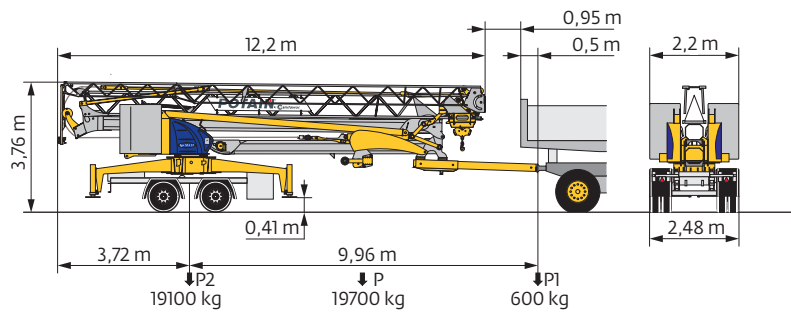

Igo MA 21 | km/h  
80

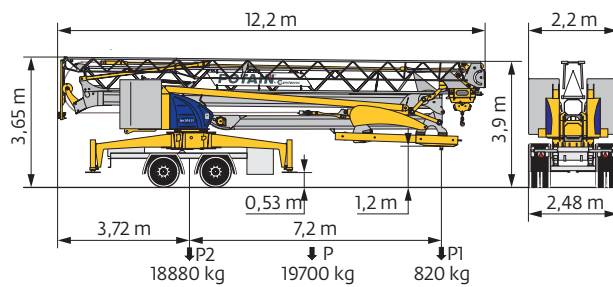

**FR**

**DE**

**EN**

**ES**

**IT**

**PT**

**RU**

<b>R</b>	Rayon de giration	Schwenk radius	Rear slewing radius	Radio de giro	Raggio di rotazione	Raio de rotação	Задний габарит
●	Réactions en service	Reaktionskräfte in Betrieb	Reactions in service	Reacciones en servicio	Reazioni in servizio	Reacções em serviço	Реакция при работе
■	Réactions hors service	Reaktionskräfte außer Betrieb	Reactions out of service	Reacciones fuera de servicio	Reazioni fuori servizio	Reacções fora de serviço	Реакция в покое
▲	Poids à vide, sans lest, sans trains de transport, avec flèche maxi. et hauteur standard.	Gewicht ohne Last, ohne Ballast, ohne Transportachsen, mit max. Auslager und Standardhöhe	Weight without load, without ballast, without transport axes, with max. jib and standard height	Peso en vacío, sin lastre, sin trenes de transporte con flecha y altura estandar	Peso a vuoto, senza zavorra, senza assali di trasporto, con braccio max e altezza standard.	Peso em vazio, sem lastro, sem eixos de transporte com lança máxima e altura standard.	Вес без груза, без балласта, без осей для транспортировки, с максимальным вылетом стрелы и стандартной высотой
▲	Poids total du lest	Ballast-Gesamtgewicht	Total ballast weight	Peso total del lastre	Peso totale della zavorra	Peso total do lastro	Общий вес балласта
↔	Trains de transport	Transportachsen	Transport axes	Trenes de transporte	Assali di trasporto	Eixos de transporte	Осей для транспортировки
↑	Levage	Heben	Hoisting	Elevación	Sollevarmento	Elevação	Подъем
◀▶	Distribution	Katzfahren	Trolleying	Distribución	Distribuzione	Distribuição	Перемещение по стреле
↻	Orientation	Schwenken	Slewing	Orientación	Rotazione	Rotação	Поворот
⚡	50 Hz Monophasé	50 Hz Einphasige	50 Hz Single phase	50 Hz Monofasica	50 Hz Monofase	50 Hz monofásica	Однофазное напряжение 50Hz
kVA	Puissance nominale	Nennleistung	Rated power	Potencia nominal	Potenza nominale	Potência nominal	Номинальная мощность
🚛	Transport grue toute lestée.	Krantransport mit voller Ballastierung.	Transport of crane with full ballast.	Transporte grúa completamente lastrada.	Trasporto con gru completamente zavorrata.	Transporte de grua totalmente balastrada.	Перевозка крана с полным балластом

**⚠** Document commercial non contractuel. Pour toute information technique se référer à la notice correspondante. Unverbindliches Vertriebsdokument. Für technische Informationen, siehe die entsprechenden Anweisungen. This commercial document is not legally binding. For any technical information, please refer to the corresponding instructions. Documento comercial no contractual. Para cualquier información técnica, ver la noticia correspondiente. Documento commerciale non vincolante, per tutte le informazioni tecniche fare riferimento al catalogo istruzioni. Documento comercial não contractual. Para qualquer informação técnica complementar consultar as respectivas instruções. Этот коммерческий документ не является юридически обязательным. Для получения технической информации, см. соответствующие инструкции.



**Manitowoc - Americas**  
**Manitowoc, Wisconsin, USA**  
Tel: +1 920 684 6621  
Fax: +1 920 683 6277

**Shady Grove, Pennsylvania, USA**  
Tel: +1 717 597 8121  
Fax: +1 717 597 4062

**Manitowoc - Europe, Middle East & Africa**  
**Ecully, France**  
Tel: +33 (0)4 72 18 20 20  
Fax: +33 (0)4 72 18 20 00

**Manitowoc - Asia & Pacific**  
**Shanghai, China**  
Tel: +86 21 6457 0066  
Fax: +86 21 6457 4955

Ref.: Igo MA 21 200936 - 2